



MY2022+ Sprinter: 360 Degree Camera(JB1_JB2_JB3)

Technical Bulletin

Version 4/4/2022
Mercedes-Benz Vans, LLC

Mercedes-Benz



Notice

Mercedes-Benz USA, LLC does not warrant the accuracy of the information contained in this bulletin and reserves the right to modify or append this bulletin without prior notification. Mercedes-Benz disclaims all liability associated with the provision of this bulletin.

This bulletin is not intended to serve as a work instruction, but merely to provide some helpful information for upfitters to take into consideration before retrofitting or modifying a Mercedes-Benz or Freightliner Sprinter.

Prior to making any modification to or installing any equipment in or on a Mercedes-Benz or Freightliner Sprinter, you should review and insure compliance with all applicable laws and regulations, consult with Upfitter Management Vans for additional and updated information, and read the Body & Equipment Guidelines (BEG) for Sprinter Model Series 907.

Upfitter Management Vans Contacts:

For information or upfitter inquiries
please submit a request via our website:

www.upfitterportal.com

MY2022+ Sprinter – Installation of 360 Degree Camera

Overview

General Description: Cameras are placed on the front, rear, left, and right sides of the vehicle. Videos from these four cameras are sent to the on-board ParkMan ECU, which stitches these video feeds to create the 360° view of the vehicle surroundings. The system assists you, e.g. when parking or at exits with reduced visibility. The 360° Camera is only an aid, it's not a substitute for your attention to the surroundings. The responsibility for safe maneuvering and parking remains with the driver. Make sure that there are no persons, animals or objects etc., in the maneuvering area while maneuvering and parking.

360 Camera(code JB1/JB2/JB3 +-(XJ4);

- Front bumper[A9108858100] inclusive ULS [A0009055504]
- Cooler grill [A9108852600] inclusive Front Camera [A0009055505]
- ParkMan ECU [A0009004534]
- Main wiring harness interface(Bundle)

To be installed by Upfitter(code JB1, JB2, or JB3):

- 3 cameras(1 Passenger side, 1 Driver Side, and 1 Rear) [A0009056206]
- 3x rear video line(15m)(A9078272700) **(Please see ordering details slide)**

Note: *Camera-housing solution will need to be produced & procured by Upfitter, 3D “basic” design can be found on Upfitter Portal and only available to Expert Upfitter’s.*

For more information, visit Upfitter Portal (www.UpfitterPortal.com) for 3D CAD data.

MY2022+ Sprinter – Installation of 360 Degree Camera

Overview of Clusters A, B and C

General Description: Major RV models from North America are categorized into 3 dimensional clusters, A(JB1), B(JB2) & C(JB3). Each cluster has a customized solution to create a more precise integration. Please find below the corresponding RV, length, height and width breakdown within each cluster.

Metric

Cluster	length (mm)	height (mm)	width (mm)	width (with mirrors) (mm)	wheelbase (mm)
A(JB1)	7797,8	3454,4	2286	2344,42	4325
	7823,2	3403,6	2286	2344,42	4325
	7772,4	3352,8	2293,62	2344,42	4325
B(JB2)	7645,4	3200,4	2413	2413	4325
	7747	3429	2413	2413	4325
	7670,8	3479,8	2438,4	2438,4	4325
C(JB3)	7493	3480	2388	2388	4325
	7544	3200	2515	2515	4325
	7544	3404	2286	2344	4325
	7595	3277	2337	2344	4325
	7595	3353	2344	2344	4325

Imperial

Cluster	length (in)	height (in)	width (in)	width (with mirrors) (in)	wheelbase (in)
A(JB1)	307	136	90	92.3	170.28
	308	134	90	92.3	170.28
	306	132	90.3	92.3	170.28
B(JB2)	301	126	95	95	170.28
	305	135	95	95	170.28
	302	137	96	96	170.28
C(JB3)	295	137	94.01	94.01	170.28
	297	125.98	99.01	99.01	170.28
	297	134.01	90	92.28	170.28
	299	129.01	92	92.28	170.28
	299	132	92.28	92.28	170.28

Cluster A Camera Positions(JB1)



MY2022+ Sprinter – Installation of 360 Degree Camera(JB1)

Cluster A driver side nominal camera position

Measured from the reference point of center of rear wheels and ground level, the defined nominal **Driver Side** camera position is listed below as:

- 1655mm/65.16in from the wheel center of the rear axle(Z-Coordinate)
- 458mm/18.03in inward direction, towards cab-chassis(Y-Coordinate)



Note: Please make sure to consider position and rotation deviation tolerances for mounting purposes shown in **slide 10**.

MY2022+ Sprinter – Installation of 360 Degree Camera(JB1)

Cluster A passenger side nominal camera position

Measured from the reference point of center of rear wheels and ground level, the defined nominal **Passenger Side** camera position is listed below as:

- 1655mm/65.16in from the wheel center of the rear axle(Z-Coordinate)
- 458mm/18.03in inward direction, towards cab-chassis(Y-Coordinate)



Note: Please make sure to consider position and rotation deviation tolerances for mounting purposes shown in **slide 10**.

MY2022+ Sprinter – Installation of 360 Degree Camera(JB1)

Cluster A rear nominal camera position

Measured from the reference point of center of rear axle and ground level, the defined nominal rear camera position is listed below as:

- 2565mm/100.98inches from center of the rear axle(Z-Coordinate)
- 0mm/0in (Y-Coordinate)

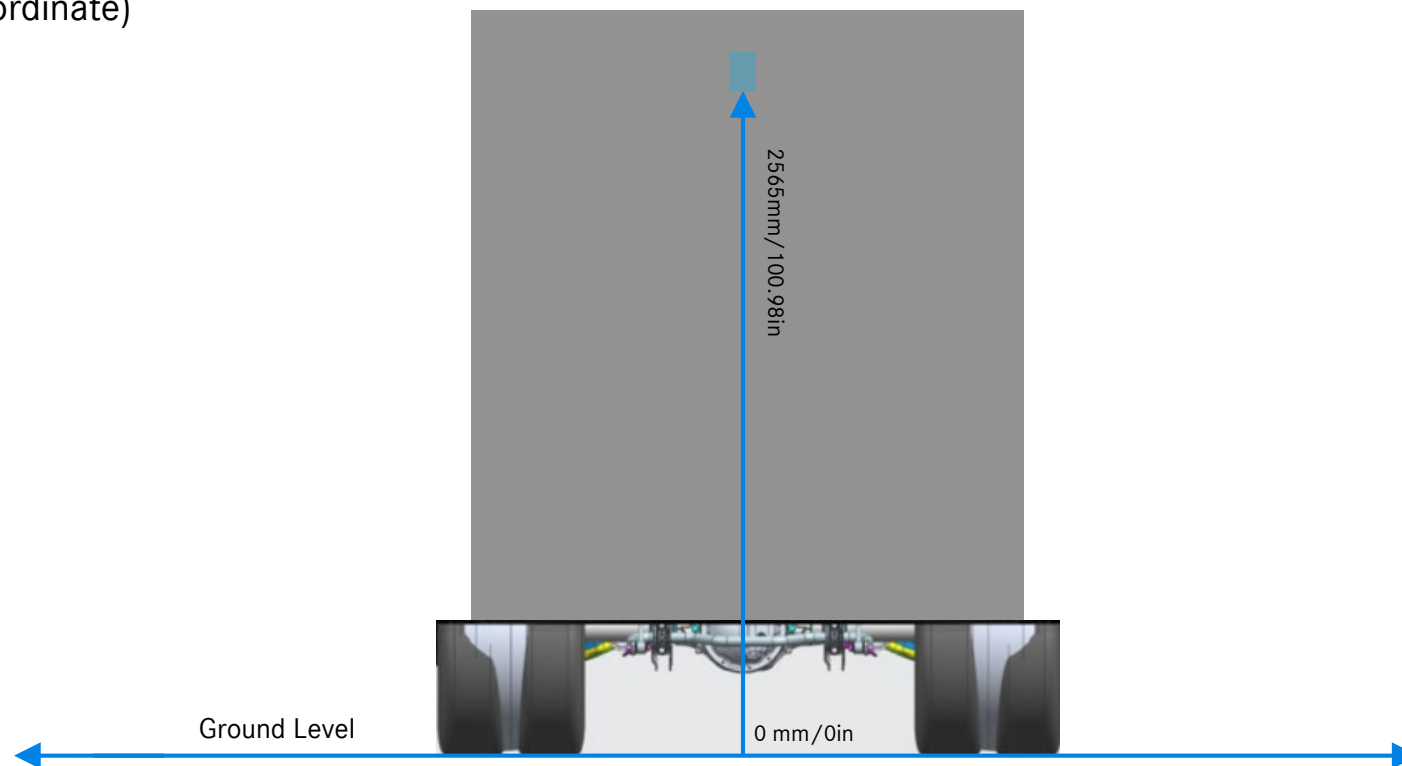

Note: Please make sure to consider position and rotation deviation tolerances for mounting purposes shown in **slide 10**.

MY2022+ Sprinter – Installation of 360 Degree Camera(JB1) Cluster A Front camera Position [Ex-Factory Install]

For information only: Front camera is pre-installed Ex-Factory, the defined **Front** camera position is listed below as:

- 793mm/31.22in center of cab chassis(Z-Coordinate)
- 0mm/0in inward direction, “center of cab-chassis”(Y-Coordinate)



Note: Any changes to the sensor and camera systems installed ex-factory must be avoided.

MY2022+ Sprinter – Installation of 360 Degree Camera(JB1) Cluster A Calibration Position and Rotation Tolerance Limit

Note:

Position deviation tolerance(as related to the nominal position of the Cluster):

X, Y & Z positions: The tolerance for lens position is maximum ± 50 mm / ± 1.96 in, as related to the nominal values. Higher tolerance deviations are not allowed.

Rotation deviation tolerance(Nominal = 0° with respect to z-axis; no yaw and roll):

X: ± 2 degree

Y: ± 2 degree

Z: ± 2 degree



Cluster B Camera Positions(JB2)



MY2022+ Sprinter – Installation of 360 Degree Camera(JB2)

Cluster B driver side nominal camera position

Measured from the reference point of center of rear wheels and ground level, the defined nominal driver side camera position is listed below as:

- 1225mm/48.22in from the wheel center of the rear axle(Z-Coordinate)
- 695mm/27.36in inward direction, towards cab-chassis(Y-Coordinate)



Note: Please make sure to consider position and rotation deviation tolerances for mounting purposes shown in **slide 16**.

MY2022+ Sprinter – Installation of 360 Degree Camera(JB2)

Cluster B passenger side nominal camera position

Measured from the reference point of center of rear wheels and ground level, the defined nominal passenger side camera position is listed below as:

- 1225mm/48.22in from the wheel center of the rear axle(Z-Coordinate)
- 695mm/27.36in inward direction, towards cab-chassis(Y-Coordinate)



Note: Please make sure to consider position and rotation deviation tolerances for mounting purposes shown in **slide 16**.

MY2022+ Sprinter – Installation of 360 Degree Camera(JB2)

Cluster B rear nominal camera position

Measured from the reference point of center of rear axle and ground level, the defined nominal rear camera position is listed below as :

- 2707mm/106.57in from center of the rear axle(Z-Coordinate)
- 0mm/0in (Y-Coordinate)

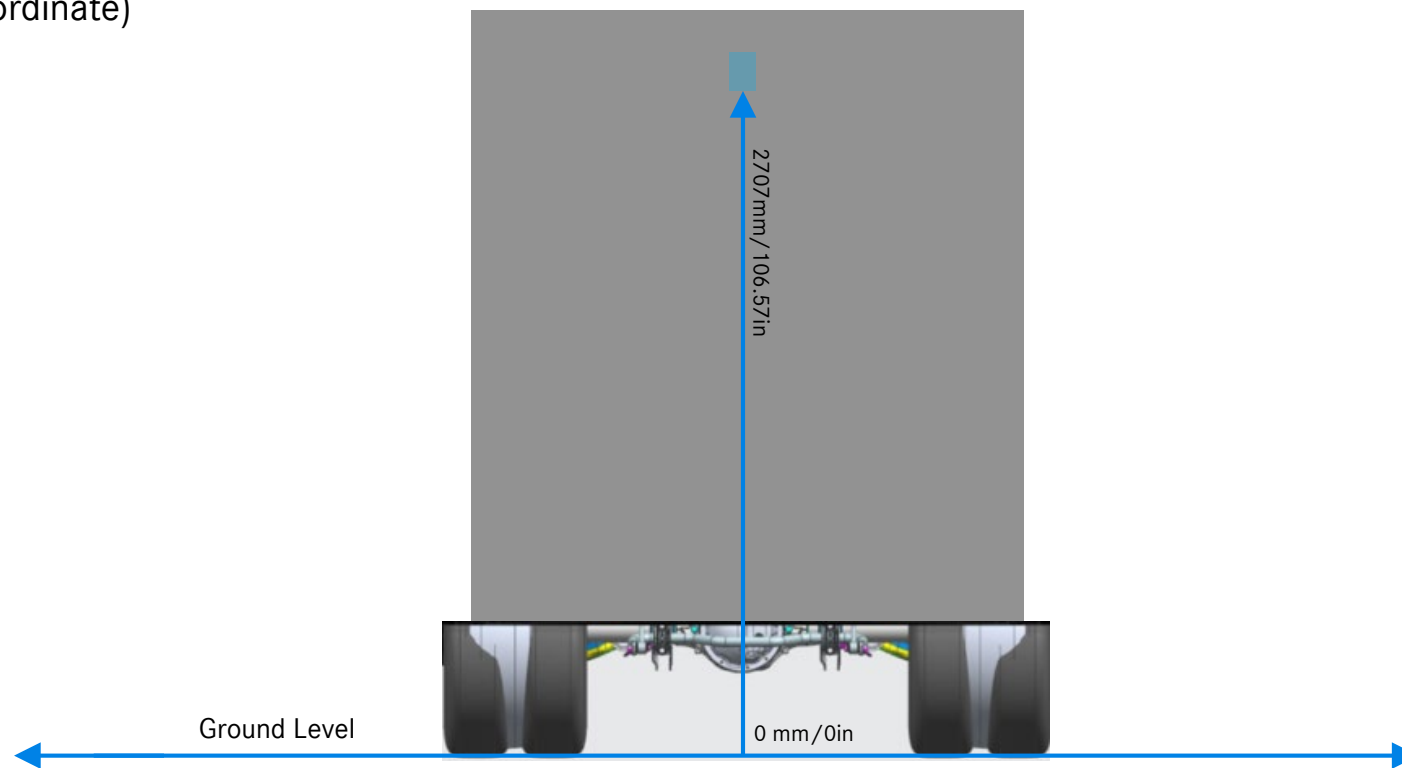

Note: Please make sure to consider position and rotation deviation tolerances for mounting purposes shown in **slide 16**.

MY2022+ Sprinter – Installation of 360 Degree Camera(JB2)

Cluster B Front camera Position [Ex-Factory Install]

For information only: Front camera is pre-installed Ex-Factory, the defined **Front** camera position is listed below as :

- 793mm/31.22in center of cab chassis(Z-Coordinate)
- 0mm/0in inward direction, “center of cab-chassis”(Y-Coordinate)



Note: Any changes to the sensor and camera systems installed ex-factory must be avoided.

MY2022+ Sprinter – Installation of 360 Degree Camera(JB2) Cluster B Calibration Position and Rotation Tolerance Limit

Note:

Position deviation tolerance(as related to the nominal position of the Cluster):

X, Y & Z positions: The tolerance for lens position is maximum ± 50 mm / ± 1.96 in, as related to the nominal values. Higher tolerance deviations are not allowed.

Rotation deviation tolerance(Nominal = 0° with respect to z-axis; no yaw and roll):

X: ± 2 degree

Y: ± 2 degree

Z: ± 2 degree

Cluster C Camera Positions (JB3)



MY2022+ Sprinter – Installation of 360 Degree Camera(JB3)

Cluster C driver side nominal camera position

Measured from the reference point of center of rear wheels and ground level, the defined nominal **driver side** camera position is listed below as:

- 1600mm/62.99in from the wheel center of the rear axle(Z-Coordinate)
- 654mm/25.75in outward direction, away from cab-chassis(Y-Coordinate)



Note: Please make sure to consider position and rotation deviation tolerances for mounting purposes shown in **slide 22**.

MY2022+ Sprinter – Installation of 360 Degree Camera(JB3)

Cluster C passenger side nominal camera position

Measured from the reference point of center of rear wheels and ground level, the defined nominal passenger side camera position is listed below as:

- 1600mm/62.99in from the wheel center of the rear axle(Z-Coordinate)
- 654mm/25.75in outward direction, away from cab-chassis(Y-Coordinate)



Note: Please make sure to consider position and rotation deviation tolerances for mounting purposes shown in **slide 22**.

MY2022+ Sprinter – Installation of 360 Degree Camera(JB3)

Cluster C rear nominal camera position

Measured from the reference point of center of rear axle and ground level, the defined nominal rear camera position is listed below as :

- 2452mm/96.53in from center of the rear axle(Z-Coordinate)
- 236mm/9.29in from center of rear axle towards passenger side of vehicle (Y-Coordinate)

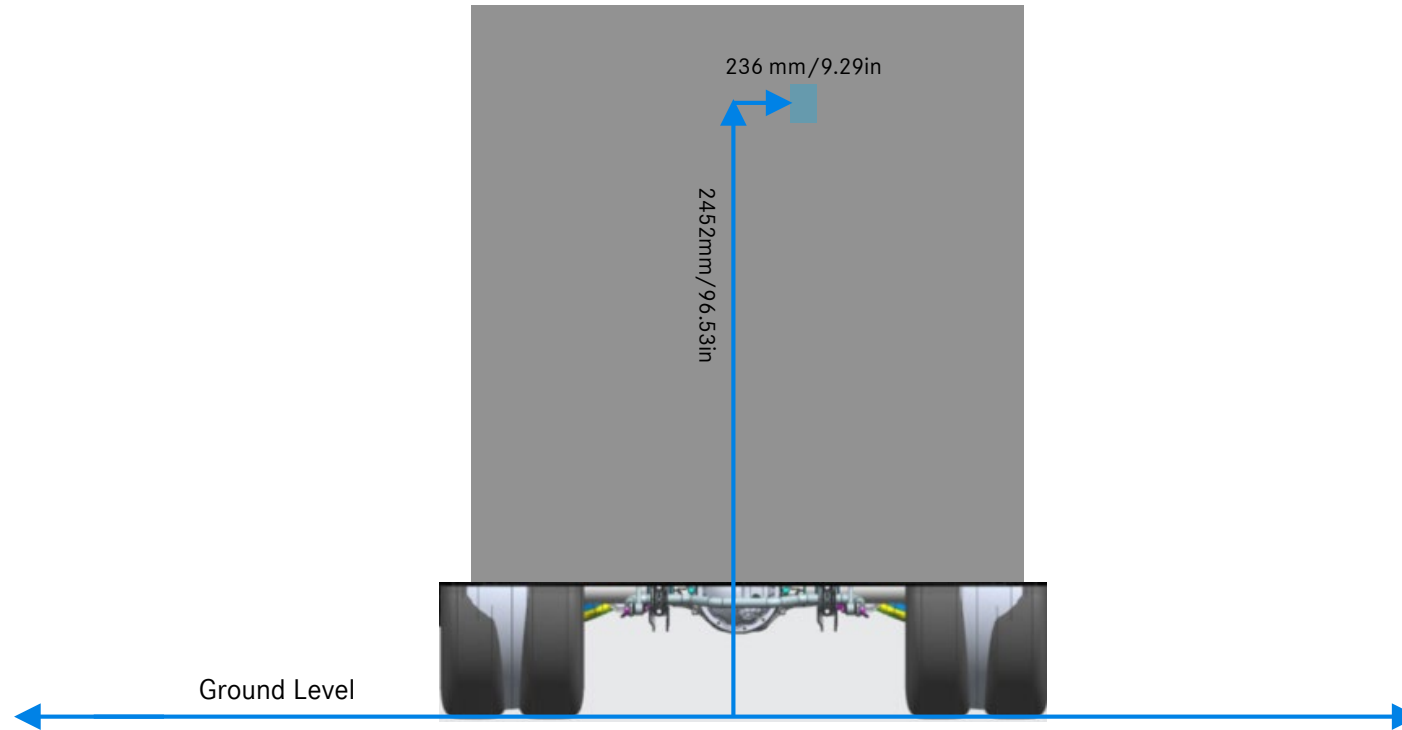

Note: Please make sure to consider position and rotation deviation tolerances for mounting purposes shown in **slide 22**.

MY2022+ Sprinter – Installation of 360 Degree Camera(JB3)

Cluster C Front camera Position [Ex-Factory Install]

For information only: Front camera is pre-installed Ex-Factory, the defined **Front** camera position is listed below as :

- 793mm/31.22in center of cab chassis(Z-Coordinate)
- 0mm/0in inward direction, “center of cab-chassis”(Y-Coordinate)



Note: Any changes to the sensor and camera systems installed ex-factory must be avoided.

MY2022+ Sprinter – Installation of 360 Degree Camera(JB3) Cluster C Calibration Position and Rotation Tolerance Limit

Note:

Position deviation tolerance(as related to the nominal position of the Cluster):

X, Y & Z positions: The tolerance for lens position is maximum ± 50 mm / ± 1.96 in, as related to the nominal values. Higher tolerance deviations are not allowed.

Rotation deviation tolerance(Nominal = 0° with respect to z-axis; no yaw and roll):

X: ± 2 degree

Y: ± 2 degree

Z: ± 2 degree

General Instructions all Clusters



MY2022+ Sprinter – Installation of 360 Degree Camera

Ordering Details-Camera Video Line and Connector

Parkman ECU is mounted Ex-Factory and 3 cameras will be included within Cab Chassis unit, however upfitters will not be supplied with video lines and corresponding connectors. Please find ordering details below and connect input video cables to corresponding positions shown in next slide.

1. LEONI DACAR 535-2 HSD Cable→3x video line(15m)-Camera video line 3 x 15m will need to be ordered separately by Upfitter. Upfitter will need to adjust length based on RV layout, dimensions, and final camera locations.
2. 3x→Rosenberger video line female connector, required for left, right and rear cameras.
Please order direct from supplier Rosenberger [D4Z005- 000]

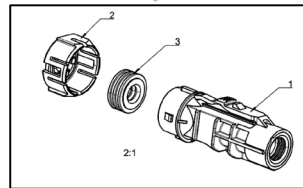

3. 3x→Rosenberger HSD female connector on ParkMan ECU; Camera Left Code A (black) , Rear Cam Code B (white) and Camera Right Code C(blue).
Please order direct from supplier Rosenberger. [D4Z001-DC0-Z]

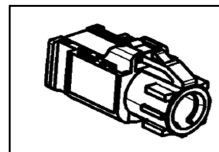

Note: Please see [slide 25](#) with **Table A** for further details on ParkMan ECU connector overview.

MY2022+ Sprinter – Installation of 360 Degree Camera

Parkman ECU Connection

Parkman ECU is mounted Ex-Factory, upfitters are supplied with main cable harness and will need to connect video cables(front, side, rear) to the corresponding positions shown below within ParkMan ECU [A0009004534] and run video cables to required positions and connect to cameras.

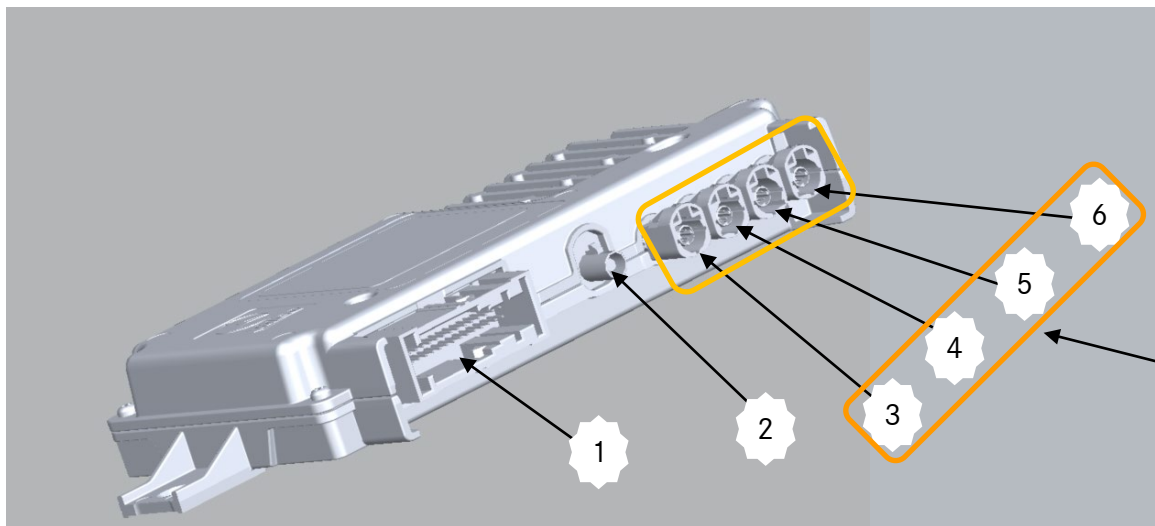
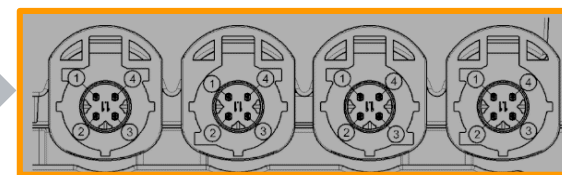
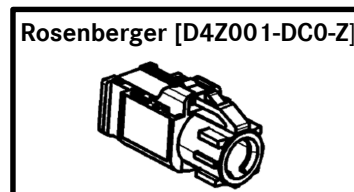

Table A

Item	Title	Color
1	32 POS MQS Press Fit Connector (AVA1680001399 Code B)	Natural(White)
2	Fakra Connector(Video out/Head Unit) (AVA0235455426 Code K)	Curry
3	Driver Side Camera Input (AVA212005399 Code A)	Black
4	Rear Camera Input (AVA2120055399 Code B)	White
5	Passenger Side Camera Input (AVA2120055399 Code C)	Blue
6	Front Camera Input (AVA2120055399 Code E)	Green

HSD Connectors(from left to right):



3. Driver Side 4. Rear 5. Passenger Side 6. Front Side

Note: ECU housing may reach 100 Deg. C / 212 Deg. F when in operation.

MY2022+ Sprinter – Installation of 360 Degree Camera(JB1, JB2, & JB3) Upfitter Camera Holder

Upfitters will be required to finalize design, procure and manufacture their own camera holder and housing. Below are recommended guidelines:

- Ensure that the camera holder is made out of a material that protects the camera from external environmental influences.
- Include two small holes for mounting camera holder to RV Body. The Upfitter may decide how to fully mount camera holder to RV sidewall's and rear.
- It is recommended to include an internal housing within the camera holder, to mechanically brace and properly seat and seal the cameras.
- **Note:** the basic design of the camera holder, uploaded to Upfitter Portal, already accounts for required camera angle as well as camera dimensions.

Additionally, it must be noted that these basic designs do not correspond to the degree of maturity of a series development and are therefore not approved by Mercedes-Benz. The body manufacturer bears sole responsibility for the use of this CAD data and the further development into a component concept ready for series production.

For reference, an example design of the camera holder, internal housing as well as the 3D data of the camera are available on the Upfitter Portal and only available to Expert Upfitter's. Please see under '360 Degree Camera 3D CAD Data' page on the Upfitter Portal.

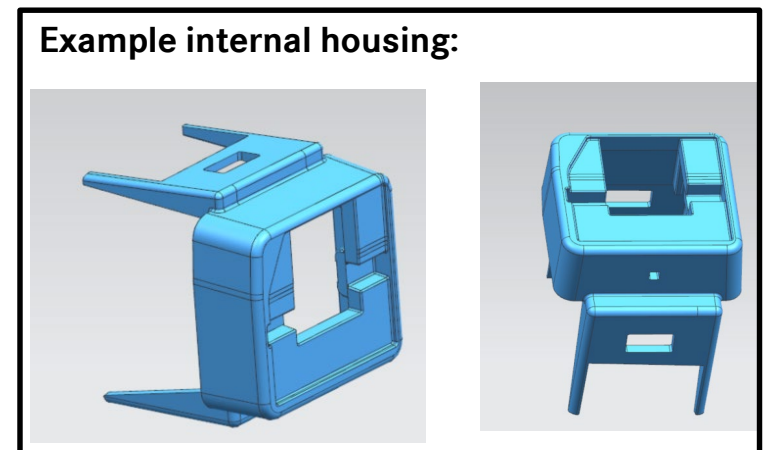
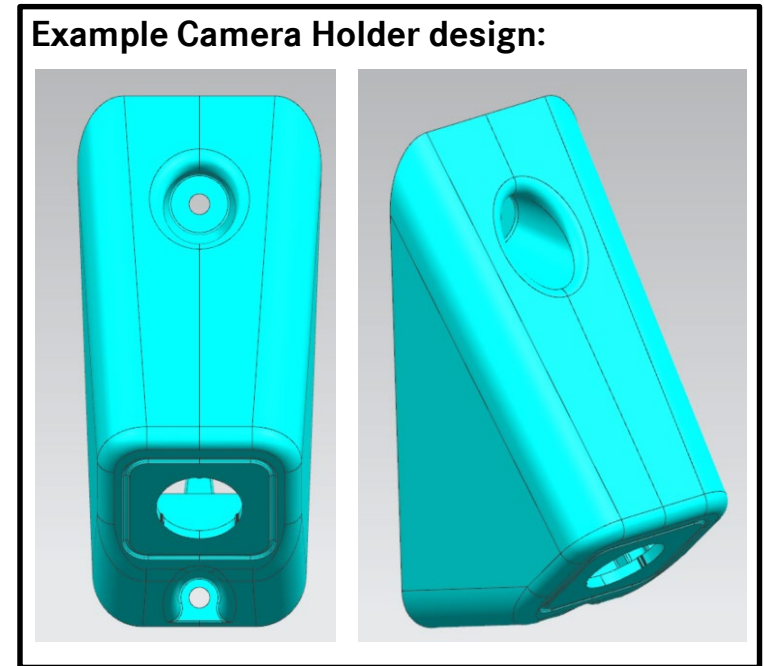

Specifications for Upfitter Camera Holder

Additional requirements to support in developing camera housing:

- Orientation of the camera (rotation around camera longitudinal axis or center axis camera lens): Camera vent must point downwards the roadway
- Horizontal tilting, no yaw and roll (rotation in the camera vertical axis): 0°
- Vertical inclination to the road (rotation around camera transverse axis): 45°
- Distance of lens to surface of body: 40mm/1.57in[with tolerance ± 5 mm/.19in]
- Please keep in mind pigtail harness (Pigtail Length 263mm/10.35in HSD Cable Diameter 4.6mm/0.18in)
- Please consider Pigtail bend radius for mounting and routing purposes as shown in **Table 1**.

Table 1:

# of cycles	Radius(mm)	Radius(in)
Single	Min R13.8	0.54
16,000	Min R20	0.79
40,00	Min R40	1.57

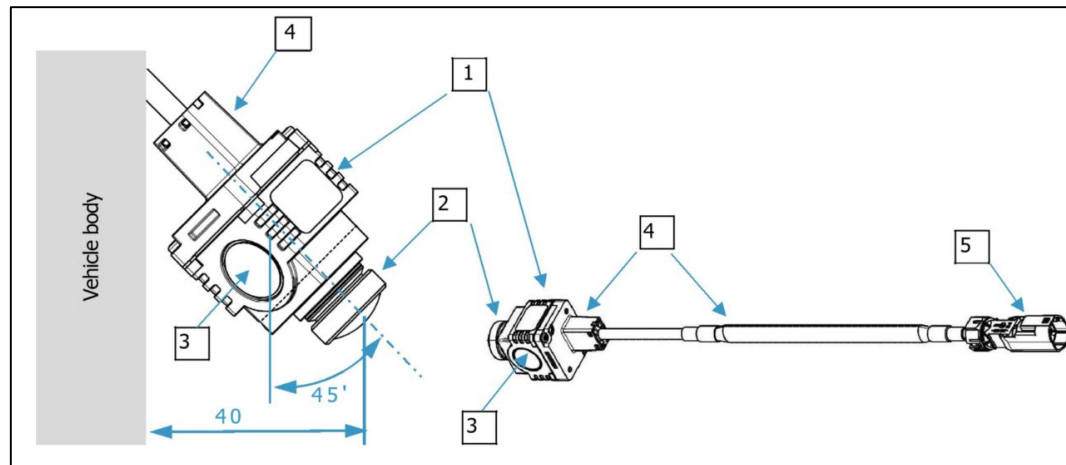

- [1] Camera assembly
- [2] Camera lens
- [3] Camera vent
- [4] Camera-side cable set
- [5] Connector to video line cable

For reference, an example design of the camera holder, internal housing as well as the 3D data of the camera are available on the Upfitter Portal and only available to Expert Upfitter's. Please see under '360 Deg Camera 3D CAD Data' page on the Upfitter Portal.

MY2022+ Sprinter – Installation of 360 Camera Mount (JB1, JB2 & JB3)

Mounting Information

To install the camera holders to the RV body side walls, the upfitter **must**:

- Position camera holder based on the provided nominal camera positions specified within the RV manufacturers' applicable cluster.

Please note: Please make sure to consider position and rotation deviation tolerances for mounting purposes shown within slides of nominal positions of clusters.

- Mount the camera holder flush to both side walls & rear wall with protruding part facing outward.
- Ensure cameras are horizontally & vertically level with camera lens pointing downward.
- Cameras must be positioned symmetrically on the left and right side wall panels.
- Mount to secure surfaces only, do not mount the camera's on movable or flexible surfaces.(i.e. , vents, doors, windows, awnings, etc.)

Please note: If feasible camera position is located within RV slide-out this is 'ok' for mounting. However please account for camera video line length as well as Pigtail Bending Radius(**Table 1**)when slide out is in outer most position.

- Make an appropriate size cutout for passing camera video line through RV body sidewalls and rear wall to connect to ParkMan Control Unit.
- It is recommended for cutout of the pigtail cable to be protected and sealed against water intrusion, corrosion, etc.

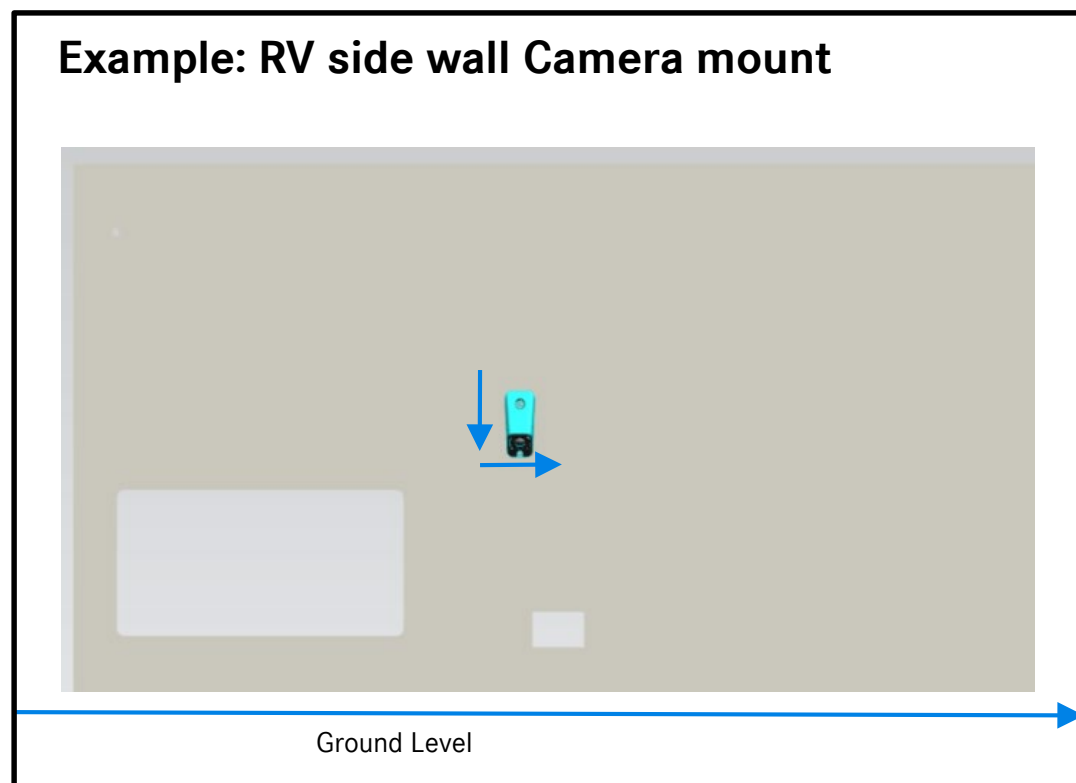

MY2022+ Sprinter – Installation of 360 Degree Camera(JB1, JB2, & JB3)

Mounting Restrictions and additional information

Please observe the following requirements when installing the 360 Parkman Camera System:

- It is recommended the vehicle be on a level ground for measuring corresponding camera positions.
- Please ensure that there are no immediate obstructions in the camera's field of view.
- Camera's must be positioned symmetrically on the left and right side wall panels.
- Connect the video cable input to the correct corresponding camera interface on the ECU harness.
- Camera vent **must be** facing towards ground plane at all camera positions as shown in **Figure 1**.

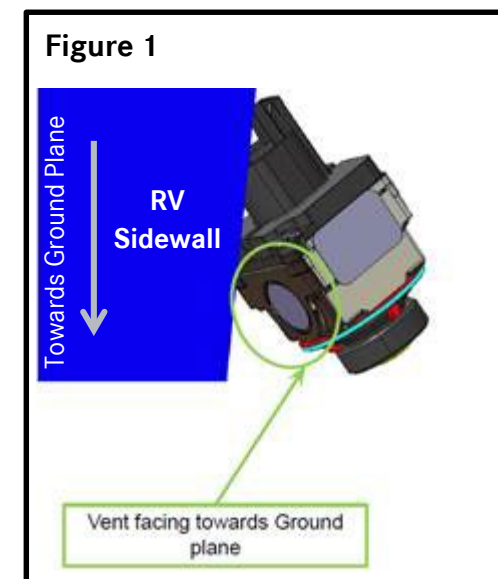

For reference, an example design of the camera holder, internal housing as well as the 3D data of the camera are available on the Upfitter Portal and only available to Expert Upfitter's. Please see under '360 Deg Camera 3D CAD Data' page on the Upfitter Portal.

Service Calibration all Clusters



MY2022+Sprinter – Service Calibration of 360 Degree Camera

Once all cameras are mounted and all wiring installed, use Xentry Diagnostic Tool to run a service calibration. If you do not have Xentry Diagnostic Tool, please visit your local dealer for the following steps.

1. **!Important!** Please remove all attachments that are within any of the cameras ‘field of view’ prior to starting service calibration(i.e., ladders, bike-racks, etc.) as this can interfere with the calibration function.
2. Preconditions for service calibration:
 - a) All doors closed (including any rear doors and engine hood)
 - b) All cameras are connected
 - c) “Camera learn” procedure must completed for all the cameras[**all channels**]
 - d) Ignition on
 - e) Mirrors should be unfolded
 - f) Speed is between 1 to 35 km/h (0.6mph - 21mph)
 - g) Steering angle should be in between +/- 1 degree
3. Start service calibration job and drive with the vehicle.
4. Head unit display will show max speed and max steering angle to comply with during service calibration, make sure to stay within displayed restrictions.
5. There will be a % complete bar on head unit displayed, continue driving through service calibration sequence until bar shows 100% complete. (**Note: Driving distance will vary from vehicle to vehicle due to external environmental circumstances**)

Please note: If tolerance of camera positions is exceeded, service calibration will not be able to compensate completely. Final stage manufacturer is responsible for ensuring that the vehicle continues to meet FMVSS requirements after any, and all upfits.

HU Display during Service Calibration

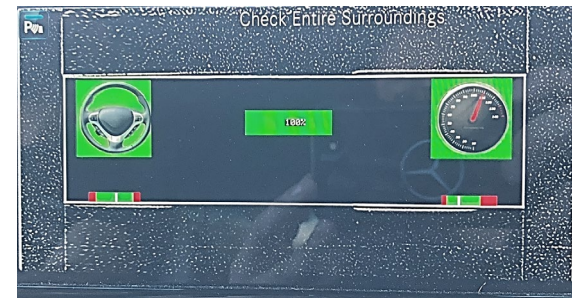
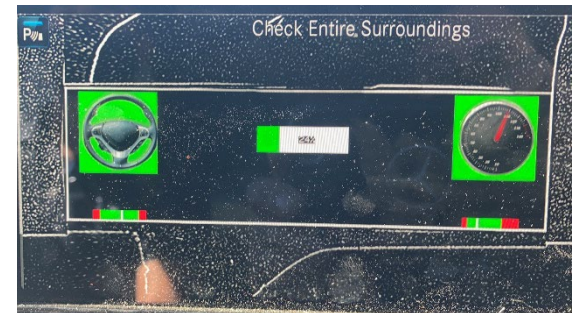

Appendix

Further Specifications

Operating Temperature: Camera will become very hot when powered, camera housing may reach 106 Deg. C/ 222.8 Deg. F when in operation, care must be taken when handling.

Installation torque: Installation torque varies depending on camera mount part materials and design.

Vent: No contact/damage on gore vent during handling or installation to vehicle. Please see **Figure 2**.

Camera Angle View: 151° (Horizontal). Please see **Figure 3**.

Camera Field of View: 194° (Vertical). Please see **Figure 3**.

Resolution: 1920 x 720

Dimensions ParkMan ECU: 238.9mm(Length) x 106.34mm(Width) x 34.3mm(Height)/ 9.4in x 4.18in x 1.35in

Camera Dimensions: 49.76mm x 29.1mm x 26.1mm / 1.96in x 1.14in x 1.03in

Notes on cleaning and care: Use clean water and a soft cloth to clean the camera lens. Do not use a power washer.

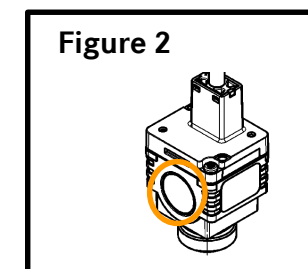

Parts	Weight (kg)	Weight (lbs.)
Camera(w/out Pigtail)	~0.032	~0.07
Camera(w/ Pigtail)	~0.05	~0.11

